

Smart Battery 2019

User Manual
Version 1.0 **EN**

To Users

Dear user, thank you for choosing XAG products.

For safety reasons and the best experience possible, XAG recommends that you read through the User Manual and Disclaimer in this document before attempting to use the Smart Battery 2019.

Contact Us

If you have any questions about this document, please contact our Technical Support via email: info@xa.com

Product Profile

The Smart Battery 2019 is available in two versions: B12620Q (standard for P20) and B12800Q (standard for P30). Both are compatible with all XAG P-Series Plant Protection UAV Modules. The Smart Battery contains 12 large-capacity lithium polymer batteries, and is integrated with a BMS module. It enables real-time monitoring of voltage, current, and temperature, and also features charging protection. During use, the battery can transmit feedback information to the device in real time. In case of low power or battery failure, the BMS system will send an emergency stop command to ensure the safety of the device.

Overview

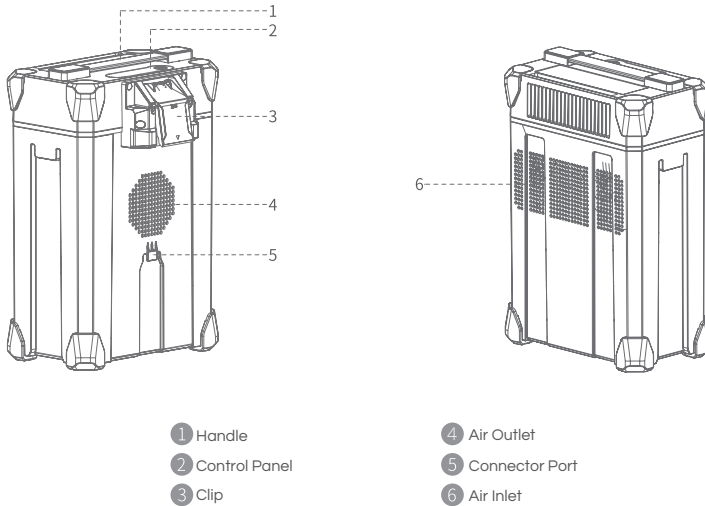

ON/OFF

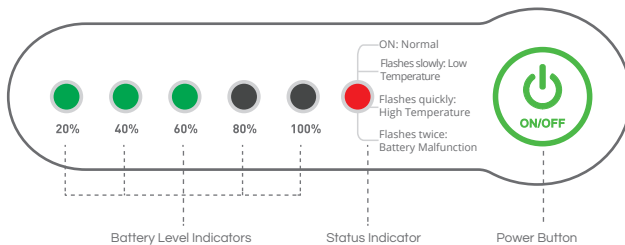

Battery ON/OFF

1. When the Battery is turned off, press the Power button once to check the current battery level, indicated by the Battery level LED. If the battery is too low, recharge before use
2. Connect the battery to an device, then press the Power button once for at least 1 second until all the indicator lights flashes, then press and hold the power button again for at least 1 second until you hear a beep from the battery.
3. Repeat Step 2 to turn off the Battery

















Battery Preheating ^[2]

Press and hold the power button for 5 seconds when the battery is OFF until a beep is heard from the battery and the status indicator is on. The pre-heating of the battery will start and the battery will turn off automatically after heating.



Checking Battery Level

When the battery is OFF, press the power button once to display the battery level.

When the battery is ON, check the battery level indicators to see the battery level.

Battery Level LED	Status	Battery Level
1 GREEN FLASH 		0%–10%
1 GREEN 		10%–30%
2 GREEN 		30%–50%
3 GREEN 		50%–70%
4 GREEN 		70%–90%
5 GREEN 		90%–100%
2 LIGHTS DOUBLE FLASH 	 Self-locked	Battery is locked caused by critical power level. Please contact customer support to unlock the device.
3 GREEN DOUBLE FLASH 	 Remotely locked	Battery is locked remotely. Please contact customer support to unlock device.

Checking Battery Status

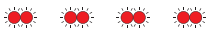
Battery Level LED	Status	Battery Level	
SOLID RED 		Normal	Normal
RED QUICK FLASH 		Overheated	Temporarily locked. Prohibited from charging and usage.
RED SLOW FLASH 		Low Temperature	Battery requires preheating.
RED DOUBLE FLASH 		Battery Malfunction	Stop using immediately.

Battery Charging

During the battery charging, the fan on the charger will be turned on to dissipate heat. The battery management system will automatically suspend the charging if the temperature is over 50° C, and resume after the temperature drops below 50° C. The ideal ambient charging temperature (20° - 35° C) for charging helps maintain the normal service life of the battery.

The battery level indicators corresponding to the current battery level will be solid green, and the remain will be flashing in series indicating the battery is currently charging. Once the charging is completed, the buzzer will beep for 30secs and all the battery level indicators will flashes for 2 minutes, then the battery will turn off automatically

[1] Device: Device as UAV or Charger

[2] Preheating: Preheating can be conducted when the battery is not connected to a device

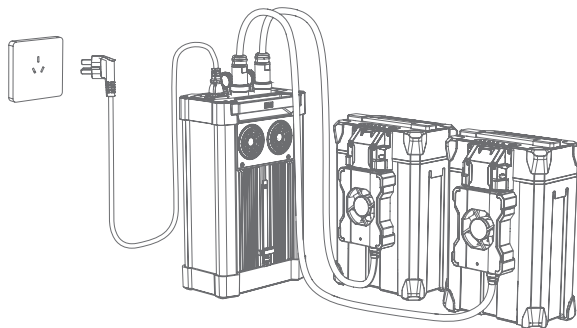

Technical Specifications

Model: B12620Q 、 B12800Q Lithium
Type: polymer battery
Capacity: 14000mAh/620Wh (B12620Q)
18000mAh/800Wh (B12800Q)
Rated output: 44.4 V /70A (B12620Q)
44.4 V /80A (B12800Q)

Operating temperature: 10 - 50 °C
Charging temperature: 10 - 40 °C
Storage temperature: -10 - 30 °C
Weight: Approx. 4.6 kg (B12620Q)
Approx. 5.4 kg (B12800Q)
Dimensions: 183*137*277 mm (B12620Q)
183*137*302 mm (B12800Q)

 IMPORTANT:

- Do not plug or unplug the battery when it is turned on, otherwise the power connector may be damaged.
- Check the battery firmware before flight operation. If there is a new version, please update first. The flight loss caused by the user's failure to update the battery firmware in time will be borne by the user.
- The battery should be used between 10° and 50° C (ambient temperature). Overheating (above 50° C) may cause the ignition or even explosion of the battery. Low temperature (below 0° C) may greatly degrade the battery performance, resulting in failure to meet the requirements of use.
- To avoid short circuiting, do not connect the positive and negative poles of the battery with a wire or other metal objects.
- Prevent the battery from coming into contact with any liquid. Please remember that it is strictly forbidden to soak the battery in water or expose the battery to water, otherwise it may lead the battery to decompose, and then spontaneous combustion or even explosion.
- If there is liquid or foreign matter on the battery terminal, wipe in a timely fashion and keep it clean. Otherwise it may cause poor contact, resulting in loss of energy or charging failure.
- Please handle with care during use. Do not disassemble it, puncture its case, or manually press the battery, including but not limited to the following: Sitting on the battery, placing heavy objects on the battery, or otherwise putting pressure on the battery.
- Regularly check the battery terminal, plug, and other components before use. Do not use alcohol or other flammable agents to clean charging devices. Do not use a damaged charging device.
- When charging, place the battery and charging devices on flat ground that is free of flammable or combustible materials. Battery charging shall be watched over to prevent accidents. For safety, when charging, a distance of more than 30cm shall be kept between two batteries, or between a battery and a charger, to avoid the malfunction of the charger or the battery, and even serious consequences such as fire due to overheating.
- Before each flight, make sure the battery has completed charging. Never operate with a full load when the battery is not fully charged.
- It is strictly forbidden to use batteries other than those provided by XAG. For replacement, please contact the after sales or designated dealers of XAG. The user shall bear the responsibility for battery accidents, flight failures or other accidents caused by the use of batteries not provided by XAG.
- In case of ONE GREEN LIGHT FLASH after flight, please charge the battery to a level of 40%-60% before storage. Failure to charge in time may cause damage to the battery. The battery should be recharged and discharged every 90 days to maintain its activity.
- The battery should be stored in a dry environment at a temperature of -10-30° C. Do not place the battery where leakage may occur.
- When the battery is found swollen, leaking, or damaged, stop using the battery immediately and contact XAG or your dealer timely.
- The liquid inside the battery is highly corrosive. If it inadvertently comes into contact with your skin or eyes, rinse with clean water and seek medical advice immediately.
- When disposing the battery, please follow local laws and regulations. Protect the natural environment, and do not discard the battery at random.

Disclaimer

1. Please read this document carefully before using this product. This Disclaimer has an important impact on the safe use of the product and your legitimate rights and interests. The use of the product shall be deemed as you have known, understood, acknowledged, and accepted all terms and contents of this document.
2. This product is not a toy, and is not suitable for people under the age of 18. Please keep this product away from the reach of children, and be very careful when operating in the presence of children.
3. This product must be charged with the charging devices provided by XAG. For product malfunction or damage caused by the use of other devices for charging, XAG does not bear the corresponding legal responsibility.
4. Please install and use this product as guided by the "Product Manual/Operation Manual". Do not modify or disassemble the product without authorization. All losses caused by the user's unauthorized modification or disassembly of this product shall be borne by the user, while XAG does not assume any corresponding legal responsibility.
5. To the maximum extent permitted by law, XAG shall not be liable for all losses caused by users' failure to use the product in accordance with this document and the "Product Manual/Operation Manual".
6. To the maximum extent permitted by law, XAG's liability or amount under any circumstances to you for all damages, losses, and litigation arising therefrom will not exceed the amount paid to XAG by you for the purchase of the product.
7. In any case, the purchaser or user shall comply with relevant laws and regulations of the country and region where the product is used. XAG does not assume any liability arising from violation of relevant laws and regulations by the purchaser or user.
8. As laws in some countries may prohibit exemptions from liability clauses, your rights in different countries may vary. This does not mean that the contents of this Disclaimer are necessarily invalid.
9. To the extent permitted by law, XAG has the final right to interpret and modify the above terms. XAG has the right to update, modify, or terminate these terms through its official website, the "Product Manual/Operation Manual", online APP and other means without prior notice.



WARNING:

- Users are required to read the complete "Product Manual" and be familiar with the product operations before using the product. Otherwise, it may cause serious injury to yourself or others, or cause product damage and property loss. Strong safety awareness is required to operate this product. Do not use the parts that are not provided or suggested by XAG. Please strictly follow the instructions of XAG to install and use the product.



info@xa.com



@XAGofficial



@XAG_official



@XAG Official



MAKE AGRICULTURE SMARTER

This Manual is subject to update without prior notice.

©XAG Co., Ltd. All Rights Reserved.

All information of this User Manual (including but not limited to any text description, illustrations, photos, methods and processes, etc.) belongs to XAG Co., Ltd. and is protected by copyright law. Without written authorization, no individual or institution is allowed to reproduce, extract, translate, distribute or otherwise reproduce or quote any content hereof.